

gatetracker

- CRM for gate installers
 - Technical Files
- Compliance Documents

September 2013

GateTracker Summary

- Simple online gate installation tracking program
- Company based log in & branding (dhf.gatetracker.co.uk)
- Record completed automation projects in detail:
 - Client & site addresses
 - Installation dates and product information
 - Risk assessment
 - Technical file information
- Auto generate client handover paperwork
- Upload client documents i.e. `force_test_results.pdf`



GateTracker Detail

- Full CRM solution for gate installers
- Track clients from new enquiry to completed install
- Automated personalised/ branded emails to clients to
 - Chase quotes
 - Installation feedback
 - Start service plan
- Book surveys, track quotes, manage repairs
- Installation, Service and Repair Diaries
- Search clients by name, phone, post code, house name etc
- Transfer old gates to new owners
- Personalised 'in-tray' with relevant actions
- Reporting and statistics

GateTracker New Features

- MapIt – locate installs, services & repairs in real time

- Service module

- add service plans for clients
- Services automatically scheduled
- Auto renewal reminders for clients

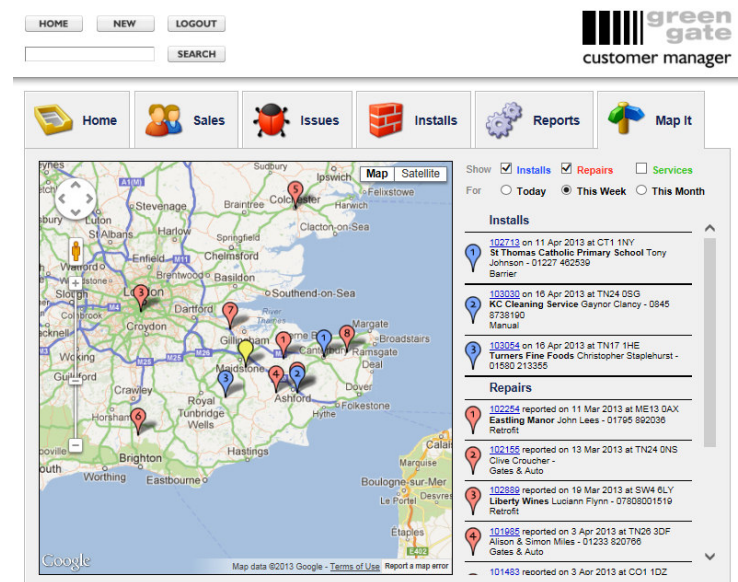

- Repairs & services emails/texts direct to engineer

GateTracker : Clients

Add New Client

Search Clients

Site information

Client information

Actions area

Installation specifics

HOME NEW LOGOUT

SEARCH

DHF

Mr Test
Need a Gate Ltd

Reference: [102234](#) EDIT

Status: [InterSales](#)

Office: DHF

Staff: Bob Perry

Type: Gates & Auto

Enquiry Date: 26th July 2012

Survey Date: 31st July 2012 @ 0

Quote Date: 31st July 2012

Sold Date: 31st July 2012

Install Date: 31st July 2012

Short Name: Front Gates

Description: *Requires new double ornamental gate with remote controls, auto exit loop and GSM Intercom*

Quote Price: £4,000.00

Buy Price: £2,500.00

Man Days: 4

Close %: 85%

Install Address: Example Lane, St Town, County, B79 7JH

Mr Test
Need a Gate Ltd

Reference: [12163](#) EDIT

Name: Mr Test

Company: Need a Gate Ltd

Source: Website

Telephone: 01234 123456

Email:

Customer Address: Example Lane, St Town, County, B79 7JH

Actions

COMPLETE QUOTE

TRANSFER QUOTE

Installation Details
Example Lane, St Town, County, B79 7JH

Install Date: 31st July 2012 EDIT

Warranty: 1 year

Warranty Expires: 26th July 2013

Description: *Double ornamental gates with underground motors. 24V system with encoder safety and safety edges on gate bases. Finger guards fitted to hinge area. GSM Intercom, radio fobs and auto exit loop*

Serial: *boards SIG9376, motors 67239h/52323f, Intercom 9849jndkgh*

Chip Board:

Keycode: *4783enter*

Fob Type: F102rs

Fob Count: 2

DAC Time: *12 seconds*

Further Notes: *Intercom fitted to wooden post 2m in front of gate, exit loop fitted 3m clear of sweep area*

- Invoiced & Deposit
- Job sheet & Handover
- Gate Drawings
- Stock Order Complete
- Customer Informed

Handover Pack

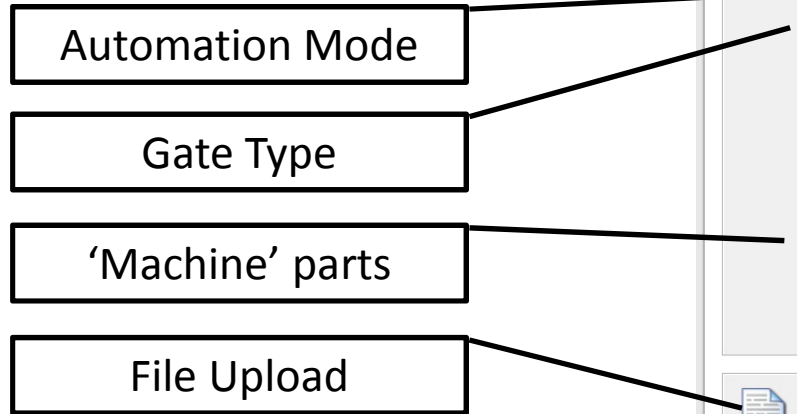

 **Handover Pack**
Example Lane, St Town, County, B79 7JH

Handover Pack PDF EDIT

Automation Fully Automatic

Gate Diagram Double Gate

Specific Notes intercom fitted to wooden post 2m in front of gate, exit loop fitted 3m clear of sweep area.

Components

Type	Category	Manufacturer	Component	Technical PDF	Customer PDF
✗ Automation	Control Panel	Nice	MC824H (Moon)	view document	
✗ Automation	Motor	Nice	Metro 24V	view document	view document
✗ Activation	Induction Loop - EXIT	Nice	Induction Loop - Exit		
✗ Activation	Intercom	Videx	4000 series GSM	view document	
✗ Activation	Remote Control	Nice	ON1/ON2	view document	view document
✗ Safety	Infrared Beam	Nice	MOFB	view document	
✗ Safety	Resistive Edge	ASO	Category 3 contact edge		

 **Quote Documents**

Document	Size	Uploaded At	Uploaded By	Actions
HandoverPack_102234.pdf	1.6 Mb	26 Jul 2012 06:31	Bob Perry	DELETE

BROWSE UPLOAD

Risk Assessment

Automation Mode

Select gate layout

Site specific notes

Risk diagram

Risk measures

Save changes

HOME NEW LOGOUT

SEARCH

DHF

Handover Pack

Automation: Fully Automatic

Gate Diagram: Double Gate

Specific Notes: Intercom fitted to wooden post 2m in front of gate, exit loop fitted 3m clear of sweep area.

Hazard 1	Close line protected against close on obstacles by infra red beam and contact reverse
Hazard 2	Sweep area protected against close on obstacles by infra red beam and contact reverse
Hazard 3	Safety edges fitted to leading edge of gate and to bases
Hazard 4	Safety edges fitted to gate bases. no walls to open against
Hazard 5	rubber finger guards fitted to protect hinge area
Hazard 6	DI-pole Isolator at gate and RCD spur in garage
Hazard 7	
Hazard 8	

SAVE CHANGES

Print Handover Pack

- Risk Assessment
- Declaration of conformity
- Parts list
- Maintenance pages
- Information pages
- Sign off sheets
- PDF saved on system
- Ready to print & bind

DHF
Door & Hardware Federation

Gate Automation Information Pack



- Safety Instructions
- Manual Release Instructions
- System Details
- Maintenance / Service Plans
- Declaration of Conformity



User Manual and Service Book

DHF
Door & Hardware Federation

Declaration of Conformity

On behalf of the company:

Company Name: The Door and Hardware Federation
Address: 42 Heath Street, Tarnworth, Sheffield, S75 7JH
Postcode: S75 7JH
Telephone Number: 01274 12337
Company Registration No: 232727
VAT Registration No: 240112234

Declares under its own responsibility that the product...

Description: Double ornamental gates with underground motors. 24V system with encoder safety and safety edges on gate bases. Finger guards fitted to hinge area. 500kN impact, anti-bounce and anti-rollback.

Serial Numbers: [blank]
Location Address: [blank]
Postcode: S75 7JH
Telephone Number: 01274 12345
Customer Name: Mr Test (Not a GSE Ltd)

...complies with the following legal directives (where specifically applicable):
Machinery Directive 2006/42/EC
Construction Materials Directive 89/106/EEC
Low Voltage Directive 73/23/EEC - 1988/EEC
Electromagnetic Compatibility Directive 89/336/EEC - 1992/EEC
RETT Directive 1995/6/EC

The products included in this declaration are included in full compliance with the following standards:
EN 12445 Industrial doors and gates: Safety use of power operated doors - Requirements
EN 12446 Industrial doors and gates: Safety use of power operated doors - Test Methods
EN 12846 Industrial doors and gates: Mechanical Aspects - Requirements
EN 12848 Industrial doors and gates: Mechanical Aspects - Test Methods
EN 60204-1 Safety of Machinery - Electrical Equipment of Machines

The validity refers to what is performed and used by the Declarant for the construction and operation of the mentioned product. Validity is lost in the following cases:
1. Changes made to the product that are unauthorised by the Declarant;
2. The responsibility accepted by the Declarant and regarding the maintenance of suitable safety- and good-operation standards, provided for by law, are not respected;
3. In the event of improper use of the product.

Authorised Signature: _____ Print Name: _____ Date: _____

Potential Installation Hazards

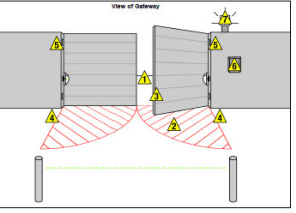

View of Gateway

Assessment: Lower the protection against close on obstacles by infra red beam. No contact reversal. Lower the protection against close on obstacles by infra red beam and contact reversal. Finger edges fitted to leading edge of gate and to bases. Finger edges fitted to gate bases, no wails to open against roller finger guards fitted to protect hinge area. Force limiter at gate and RCD on all garage door cables.

Specific Notes: Gate must be automatically open 2m in front of gate, exit loop fitted 2m in front of gate.

Entry Keycode: 4783enter

Be aware of no additional unprovided hazards
Installer Signature: _____ Print Name: _____ Date: _____

DHF
Door & Hardware Federation

Technical Information

System Configuration - Accessories included in your installation

See your quotation or invoice for a list of items and products installed your automation system. Below is a list of additional items not itemised your quotation/invoice.

AUTOMATION SYSTEM
Control Panel - Nice MCS26H (Black)
Motor - Nice Mito 24V
Additional information about the items included in this handover pack.

ACTIVATION ACCESSORIES
Induction Loop - EXT - Nice Induction Loop - EXT
Intercom - Video 4000 Series GSM
Remote Control - Nice ONEZONE
Additional information about the items included in this handover pack.

SAFETY ACCESSORIES
Infrared Beam - Nice MCR2
Recessive Edge - ASC Category 3 contact edge

DHF
Door & Hardware Federation

Handover Check List

Once your installation is complete you should run through the following checklist with your installer to ensure you are satisfied with the finished installation. Note any items that are damaged, missing, incomplete or not operating properly. Also note if you cannot assess something because it has not yet been installed, completed or cleared.

It has been explained to you:

- How to operate the gate
- How to be the remote control
- How to isolate the power to your system
- How to manually release your system
- The safety instructions associated with automatic gates
- The hazard associated with your automatic gate
- What safety features and accessories your system includes
- What activation accessories your system includes and how to operate them
- What activation mode your system is set to
- How to change the batteries on installed wireless products (physically, keypad, remote control)
- How to perform the required monthly basic safety checks on your system

Carry out a check on the following items:

- The remote operates smoothly and without unusual noise such as banging
- The gate and gate posts are without fault, in particular hinges
- The control panel is without fault and sealed correctly
- Any interlocking devices (stop activate and protect the gate correctly)
- Safety gate operates correctly on opening/closing
- Safety edge operates on closing gate
- All remote controls and other accessories (such as keypads) work correctly
- The opening path of the gate is free from obstruction
- All fence corners and other accessories (such as keypads) work correctly
- Check that all wiring is correctly fitted and not exposed to the elements
- The gate has a completed CE conformity published certificate attached

Ensure that the following items have been provided by your installer:

- Description of materials applicable to your system
- A completed Declaration of conformity
- A completed Customer safety warning Register
- All safety accessories installed such correctly to their designed function

By signing this report the purchaser:

- Confirms the product works, that it is suitable for performing the required specification, and also that it is accepted.
- Declares having received the instructions for use and maintenance clearly printed, that he has read them and will make them available to all those authorised to use the system. Also declares he/she has received the information on the standard pertaining to the system in question.
- Undertakes to ensure that the product is used correctly and to maintain the general level of good working and state of conservation as per the provisions in the instructions for use and maintenance.
- Confirms having received the description of conformity.

Installer Signature: _____ Installer Print Name: _____ Date: _____
Customer Signature: _____ Customer Print Name: _____

Measure (Key and Laser-Operated Release) (Initial position in the event of a power failure or system malfunction)

Key-Operated Release (Fig. 1)
1. Pull down the handle to the right.
2. Insert the key and rotate 90° clockwise.
3. Press the gate remote (Fig. 2).

Laser-Operated Release (Fig. 2)
1. Pull down the handle to the right.
2. Insert the laser and rotate 90° clockwise.
3. Press the gate remote (Fig. 1).

The system will revert to automatic operation upon the first successful remote-control.

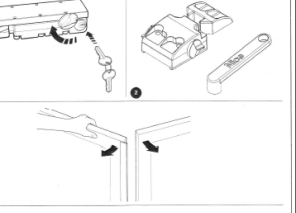

Handover pack if you wish to add a new automated system to your house, contact your installer and we will be pleased to provide the necessary information. The most developed products on the market, safety-edge, quad-drive and multi-drive.

By reading these suggestions and so that you are fully satisfied with your new system, please contact your installer for further information.

Gate Tracker : Diary and summary

HOME NEW LOGOUT

SEARCH

Home

Sales

Issues

Installs

Quotes

Reports

SHOW ALL

The following enquiries need to be dealt with:

Quote	Customer	Telephone	Postcode	Email	Type	Source	Enquiry Date
102301	Amy McClean	0	CT		Gates & Auto	Referral	21 Aug 2012
102271	David Smith	07973 139453	NG14 6DG		Retroftt - Solar	Website	8 Aug 2012

The following jobs have surveys booked and need carrying out:

Quote	Customer	Telephone	Postcode	Email	Type	Survey Date	Enquiry Date	PDF
102342	Mr Perkins	07540 704831	ME9 8LR		Gates & Auto	10 Sep 2012	3 Sep 2012	
102322	Mr S China	01634 375892	ME17 1PL		Retroftt	6 Sep 2012	28 Aug 2012	
102321	Bridgette Dungey	01622 890505	TN27 9PT		Retroftt - Solar	4 Sep 2012	28 Aug 2012	
100922	Stuart China	07860 291412	ME17 1DJ		Retroftt	6 Sep 2012	7 Apr 2012	

The following jobs need quotes prepared and sent to customers:

Quote	Customer	Telephone	Postcode	Email	Type	Survey Date
102302	John McCorry	07781 784616	BT67 0BP		Retroftt	

The following jobs need to be chased as the customer hasn't responded to the quote:

Quote	Customer	Telephone	Postcode	Email	Price	Close	Quote Date
102253	Mrs Hayes	020 84622220	BR2 7AN		£11,549.00	50%	9 Aug 2012
102251	Tom Smith	07708 972761	CT5 4DE		£4,027.00	60%	8 Aug 2012
102247	Alec Game	01622 745 109 07710 608962	ME17 3SF		£2,538.00	70%	2 Aug 2012
102212	William Wright	07957 495270	DA4 0EJ		£3,720.00	60%	26 Jul 2012
102211	Emily Govorovski	01424 813387	TN35 4AS		£2,100.00	65%	30 Jul 2012
102177	Mark Gleadell	01634 250256	ME3 8QR		£1,995.00	60%	18 Jul 2012
102163	Andy Beadle (Site manager)	01303 285521	CT21 4HL		£4,287.00	70%	11 Jul 2012
102162	Tim Metcalfe	07860 747995			£2,171.92	60%	4 Jul 2012

HOME NEW LOGOUT

SEARCH

Home

Sales

Issues

Installs

Quotes

Reports

SHOW ALL

Quote	Customer	Telephone	Postcode	Type	Days	Price	Install Date				
102266	Clive Baxter	01622 749118	ME17 4BS	Retroftt	3.1	£2,377.00	3 Sep 2012	●	●	●	●
101428	Bill Rose (Furley Park School)	01233 501732	TN23 3PA	Gates & Auto	6.5	£5,472.00	4 Sep 2012	●	●	●	●
102287	Sharon Best (Fulston Manor School)	01795 412614	ME10 4EG	Pans	1.5	£939.00	5 Sep 2012	●	●	●	●
102308	Andrew Gebhardt (Finex LLP)	02072833924	E16 2DY	Pans	0.1	£973.00	6 Sep 2012	●	●	●	●
102021	David Stovell	07850 815663	RH5 6DH	Gates & Auto - Solar	3.7	£3,600.00	7 Sep 2012	●	●	●	●
102333	Kevin Kay	01582 475677	LUS 6HD	Bollards	0.1	£3,464.00	10 Sep 2012	●	●	●	●
102254	John Lees (Eastling Manor)	01795 892036	ME13 0AX	Retroftt	3	£1,966.00	11 Sep 2012	●	●	●	●
102290	Jamie Pearson (Network Maintenance)	01322 868066	TN15 7HJ	Retroftt	3.4	£2,500.00	11 Sep 2012	●	●	●	●
102336	Derek McVicker	01795 532744 07988902544	ME13 0SD	Repair	1.5	£450.00	13 Sep 2012	●	●	●	●
102280	Mr & Mrs Dally	01483 536727	GU1 2JH	Repair	3.3	£1,150.00	14 Sep 2012	●	●	●	●
102248	Vartan Medical Systems (Richard Schonagevel)	01253 601293 07576 563110	RH10 9RG	Barrier	6	£5,300.00	17 Sep 2012	●	●	●	●
101976	Darren Ford (Birchwood Construction)	01707 659725	NW11 4RY	Retroftt	3	£2,175.00	19 Sep 2012	●	●	●	●
102213	Mr Robert Laird (SC Johnson Ltd)	01276 852000	GU16 7AJ	Barrier	3	£4,949.00	1 Oct 2012	●	●	●	●
102286	Vartan Medical Systems (Richard Schonagevel)	01253 601293 07576 563110	RH10 9RG	Manual	1	£1,086.00	3 Oct 2012	●	●	●	●
102178	David Gough-Cooper (Cooper Estates Limited)	01474 709040	DA3 7QT	Gates & Auto	6	£9,600.00	8 Oct 2012	●	●	●	●

Gate Tracker Security:

- Dedicated server
- Secure back-ups & mirror servers
- https & PCI ready
- No visibility between companies
- Selectable visibility across offices

gatetracker

- ❑ CRM for gate installers
 - ❑ Technical Files
- ❑ Compliance Documents

neil@gatetracker.co.uk

08450 030612

Gate Tracker Costs:

- Single user licence
 - £50 monthly (£540 per year -10% single payment discount)
- Single office licence, multiple users
 - £65 monthly (£700 per year -10% single payment discount)
- Multiple office licence, many users
 - £100 monthly (£1080 per year -10% single payment discount)

Only £5 per branded handover pack for a one job a week firm

- https licence £175 per annum
- Data import £poa

gatetracker

- ❑ CRM for gate installers
 - ❑ Technical Files
- ❑ Compliance Documents

neil@gatetracker.co.uk

08456 800269